

Artwork Approval

Date: _____

Your Ref:

Pantone:

Product Code: TPCPN0710

Our Ref:

Quantity:

Product Colour:

Version:

Position:

Max Print Area: 25mm x 18mm

Amendments to artwork supplied:

Special Print Requirements:

Any special print requirements must be advised at approval stage (However a new visual may have to be done and approved which may affect the lead time) We may at times advise you of our concerns with regards to the print or print colour on the PDF proof, if approval is given this is unfortunately at your own risk. If a photograph is required of the item this may be chargeable and this is quite often done on day of despatch and could delay your order if approval isn't received immediately.

100%

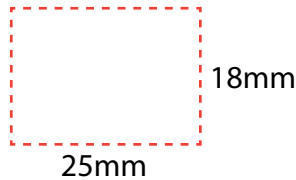
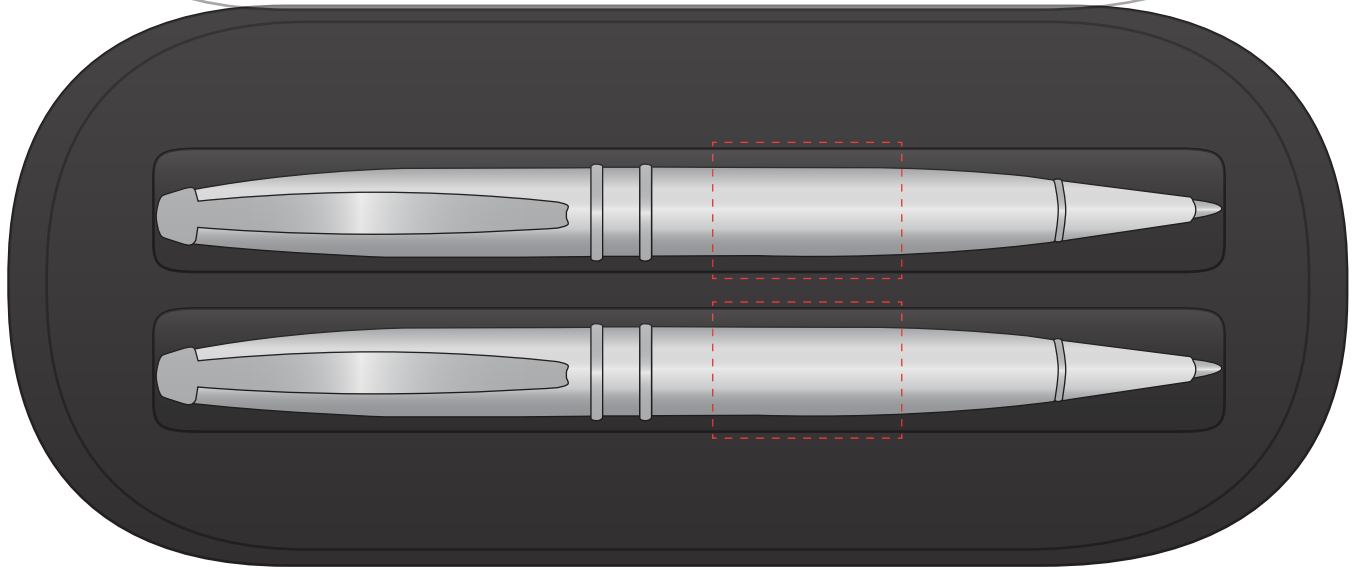

PLEASE CHECK THE FOLLOWING INFORMATION IS CORRECT AND TICK ALL THE APPROPRIATE BOXES:

By signing this proof I accept responsibility for errors which have not been corrected after proof approval

Quantity **Spelling** **Position** **Print Colour** **Print Area** Print Name:

APPROVED :) **NOT APPROVED :(** Signed: Date:

We cannot accept liability for errors, however caused, which are evident in the proof and not indicated to you at this stage. You are liable for all relevant costs incurred in correcting such mistakes once the proof has been approved. The following checklist may assist (the list is not exhaustive!) text colour, cut marks, layout, size/shape, spelling, typography, marks & other imperfections. Please note: Your order will not go into production until this proof is approved in writing. This product may have more than one print area, please check to ensure the print position is correct as mistakes cannot be rectified once the goods have been printed. If you are increasing the amount of prints or position to what is showing on your order acknowledgement additional charges will apply. The visual is not designed to be an accurate representation of the actual product or print. It is primarily to depict the desired logo for size and positional checking and sign off. Due to the restrictions and constraints of printing, we can only use 'coated' ink, therefore your pantone reference will need to be a 'C' code. Please double check the pantone colour against a coated pantone book before approving the artwork. Also the colour and texture of a product can have an effect on the final print colour.